

CLICKLIFT6750

Clicklift manhole cover frame raising system 675 x 675 x 50mm



DESCRIPTION

Clicklift manhole cover frame raising system 675 x 675 x 50mm

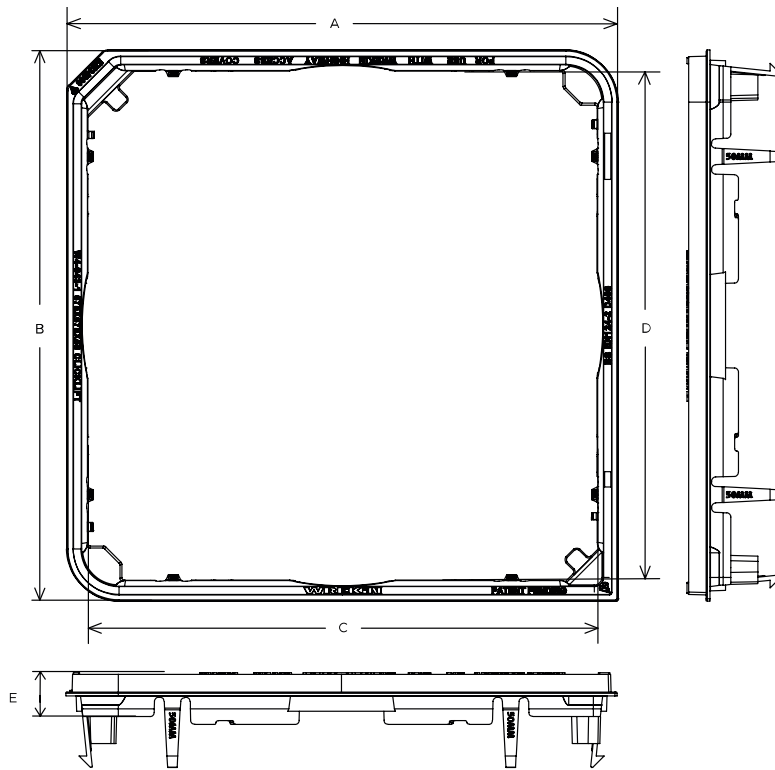

SPECIFICATION

General information

Stock code	CLICKLIFT6750
Primary material	Ductile iron

Dimensions

Overall frame (A x B)	715 mm x 715 mm
Clear opening (C x D)	675 mm x 675 mm
Frame depth (E)	50mm

NOTES

Clicklift is a BSI Kitemarked system.

CLICKLIFT COMPATIBILITY

Stock code	Size (mm)	Tristar compatible products	
		100mm depth	150mm depth
CLICKLIFT6730	675 x 675 x 30		
CLICKLIFT6740	675 x 675 x 40	DMTOD4/6767/KT	DMTOD6/6767/KT
CLICKLIFT6750	675 x 675 x 50		
CLICKLIFT6760	675 x 675 x 60		

Stock code	Size (mm)	Highway compatible products	
		100mm depth	150mm depth
CLICKLIFT6730	675 x 675 x 30	DMTOD4/6767/KH	DMTOD6/6767/KH

Stock code	Size (mm)	Highway compatible products
CLICKLIFT6740	675 x 675 x 40	
CLICKLIFT6750	675 x 675 x 50	
CLICKLIFT6760	675 x 675 x 60	

1. Wrekin Products Ltd is continually seeking to improve our products and therefore reserves the right to alter product specifications without prior notice.
2. It is the responsibility of all users to satisfy themselves the above data is current.
3. Installation details are available on request.
4. All Wrekin products are supplied subject to our [Terms and Conditions of Sale](#)

